

JENSEN[®] audio

PHONE CHARGING DUAL ALARM CLOCK RADIO

MODEL JCR-260



USER MANUAL

**PLEASE READ THIS USER MANUAL COMPLETELY BEFORE
OPERATING THIS UNIT AND RETAIN THIS BOOKLET FOR
FUTURE REFERENCE.**

Dear JENSEN® Customer

Selecting fine audio equipment such as the unit you've just purchased is only the start of your musical enjoyment. Now it's time to consider how you can maximize the fun and excitement your equipment offers. This manufacturer and the Electronic Industries Association's Consumer Electronics Group want you to get the most out of your equipment by playing it at a safe level. One that lets the sound come through loud and clear without annoying blaring or distortion and, most importantly, without affecting your sensitive hearing. Sound can be deceiving. Over time your hearing "comfort level" adapts to higher volumes of sound. So what sounds "normal" can actually be loud and harmful to your hearing. Guard against this by setting your equipment at a safe level BEFORE your hearing adapts.

To establish a safe level:

- Start your volume control at a low setting.
- Slowly increase the sound until you can hear it comfortably and clearly, and without distortion.

Once you have established a comfortable sound level:

- Set the dial and leave it there.
- Taking a minute to do this now will help to prevent hearing damage or loss in the future. After all, we want you listening for a lifetime.

We Want You Listening For a Lifetime

Used wisely, your new sound equipment will provide a lifetime of fun and enjoyment. Since hearing damage from loud noise is often undetectable until it is too late, this manufacturer and the Electronic Industries Association's Consumer Electronics Group recommend you avoid prolonged exposure to excessive noise.

Customer's Record:



The serial number of this product is found on its bottom. You should note the serial number of this unit in the space provided as a permanent record of your purchase to aid in identification in the event of theft or loss.

Model Number: JCR-260

Serial Number: _____

WARNING

TO REDUCE THE RISK OF FIRE OR SHOCK HAZARD, DO NOT USE THIS PLUG WITH AN EXTENSION CORD, RECEPTACLE OR OTHER OUTLET UNLESS THE BLADES CAN BE FULLY INSERTED TO PREVENT BLADE EXPOSURE. DO NOT EXPOSE THIS APPLIANCE TO RAIN OR MOISTURE.

 <p>The lightning flash with arrowhead symbol, within an equilateral triangle is intended to alert the user to the presence of uninsulated dangerous voltage within the products enclosure that may be of sufficient magnitude to constitute a risk of electric shock to persons.</p>	<p>CAUTION RISK OF ELECTRIC SHOCK DO NOT OPEN</p> <p>WARNING: TO REDUCE THE RISK OF ELECTRIC SHOCK, DO NOT REMOVE COVER (OR BACK), NO USER SERVICEABLE PARTS INSIDE, REFER SERVICING TO QUALIFIED SERVICE PERSONNEL.</p>	 <p>The exclamation point within an equilateral triangle is intended to alert the user to the presence of important operating and maintenance (servicing) instructions in the literature accompanying the appliance.</p>
--	--	--

The Caution Marking is located at the bottom of apparatus.

IMPORTANT SAFETY INSTRUCTIONS

1. Read all instructions.
2. Keep these instructions.
3. Heed all warnings.
4. Follow all instructions.
5. Do not use this apparatus near water.
6. Clean only with dry cloth.
7. Do not block any ventilation openings. Install in accordance with the manufacturer's instructions.
8. Do not install near any heat sources such as radiators, heat registers, stoves, or other apparatus (including amplifiers) that produce heat.
9. Do not defeat the safety purpose of the polarized or grounding-type plug. A polarized plug has two blades with one wider than the other. A grounding type plug has two blades and a third grounding prong. The wider or the third prong is provided for your safety. If the provided plug does not fit into your outlet, consult an electrician for replacement of the obsolete outlet.
10. Protect the power cord from being walked on or pinched particularly at plugs, convenience receptacles, and the point where they exit from the apparatus.
11. Only use attachments / accessories specified by the manufacturer.
12. Use only with a cart, stand, tripod, bracket, or table specified by the manufacturer, or sold with the apparatus. When a cart is used, use caution when moving the cart/ apparatus combination to avoid injury from tip-over.



13. Unplug this apparatus during lightning storms or when unused for long periods of time.
14. Refer all servicing to qualified service personnel. Servicing is required when the apparatus has been damaged in any way, such as power-supply cord or plug is damaged, liquid has been spilled or objects have fallen into the apparatus, the apparatus has been exposed to rain or moisture, does not operate normally, or has been dropped.
15. This apparatus shall not be exposed to dripping or splashing water and that no object filled with liquids such as vases shall be placed on the apparatus.
16. Main plug is used as disconnect device and it should remain readily operable during intended use. In order to disconnect the apparatus from the mains completely, the mains plug should be disconnected from the mains socket outlet completely.
17. Battery shall not be exposed to excessive heat such as sunshine, fire or the like.
18. The marking information is located at the bottom of apparatus.
19. Remark:  this is CLASS II apparatus with double insulation, and no protective earth provided.
20. **CAUTION**
Danger of explosion if battery is incorrectly replaced. Replace only with the same or equivalent type.

CAUTION:
TO PREVENT ELECTRIC SHOCK,
MATCH WIDE BLADE OF AC PLUG TO WIDE SLOT. FULLY INSERT.

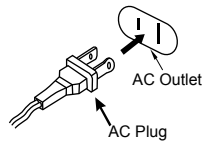

COMPLIANCE WITH FCC REGULATION

This device complies with Part 15 of the FCC Rules. Operation is subject to the following two conditions:

- (1) This device may not cause harmful interference, and
- (2) This device must accept any interference received, including interference that may cause undesired operation.

This equipment has been tested and found to comply with the limits for a class B digital device, pursuant to Part 15 of the FCC Rules. These limits are designed to provide reasonable protection against harmful interference in a residential installation. This equipment generates, uses and can radiate radio frequency energy and, if not installed and used in accordance with the instructions, may cause harmful interference to radio communications. However, there is no guarantee that interference will not occur in a particular installation. If this equipment does cause harmful interference to radio or television reception, which can be determined by turning the equipment off and on, the user is encouraged to try to correct the interference by one or more of the following measures:

- Reorient or relocate the receiving antenna.
- Increase the separation between the equipment and receiver.
- Connect the equipment into an outlet on a circuit different from that to which the receiver is connected.
- Consult the dealer or an experienced radio/TV technician for help.

CAUTION

Changes or modifications not expressly approved by the party responsible for compliance could void the user's authority to operate the equipment.

PROTECT YOUR FURNITURE!!

This system is equipped with non-skid rubber 'feet' to prevent the product from moving when you operate the controls. These 'feet' are made from non-migrating rubber material specially formulated to avoid leaving any marks or stains on your furniture. However certain types of oil based furniture polishes, wood preservatives, or cleaning sprays may cause the rubber 'feet' to soften, and leave marks or a rubber residue on the furniture.

To prevent any damage to your furniture we strongly recommend that you purchase small self-adhesive felt pads, available at hardware stores and home improvement centers everywhere, and apply these pads to the bottom of the rubber 'feet' before you place the product on fine wooden furniture.

IMPORTANT NOTES

Avoid installing the unit in locations described below:

- Places exposed to direct sunlight or close to heat radiating appliances such as electric heaters.
- Dusty, humid or moist places.
- Places subject to constant vibration.

POWER SOURCE

This unit is designed to operate on 120V ~ 60Hz AC house current. Operating this unit on any other power source may cause damage to the unit, and such damage is not covered by your warranty.

It is also equipped with a battery back-up system for the clock that is powered by an optional 9V 006P battery (type 6F22 or equivalent) – not included.

BATTERY BACK – UP SYSTEM

The Battery Back-up System ensures the clock and alarm settings will be retained during a power interruption or power outage (in order to preserve the battery life the Display will not light). All clock settings will be kept in memory, however, the clock time may require adjustment for exact accuracy once the power returns. If a battery is not installed, the Display will blink "12:00" when the power is restored. This will indicate that you have to reset the time and alarm settings.

BATTERY INSTALLATION

Note: For optimum performance an alkaline-type battery is recommended.

1. Open the battery compartment door on the bottom of the cabinet then connect one DC 9V battery to the Battery Clip located inside.

Note: The battery clip only fits one way to ensure the correct polarity.

2. Replace the Battery Compartment Door.

IMPORTANT: Be sure that the battery is installed correctly. Wrong polarity may damage the unit.

BATTERY CARE

- i. If the unit is not to be used for an extended period of time, remove the battery. Old or leaking battery can cause damage to the unit and will void the warranty.
- ii. Do not try to recharge batteries not intended to be recharged; they can overheat, rupture and leak. (Follow battery manufacturer's directions.
- iii. Do not dispose of batteries in fire, batteries may leak or explode.

POWER FAILURE INDICATOR

If there is no battery installed in the unit or the battery installed is weak or dead, the time and alarm settings will be lost if the power is interrupted. When the AC power is restored the display will flash "12:00". This indicates that the time displayed is incorrect and needs to be reset.

IMPORTANT:

After you reset the time, be sure to reset your alarm settings as well.

LOCATION OF CONTROLS AND INDICATORS

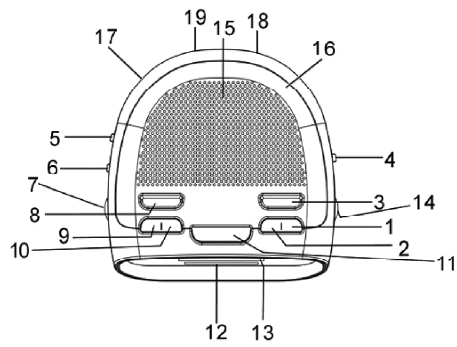

1. CLOCK/ALARM TIME SLOW SET BUTTON	11. SNOOZE BUTTON
2. CLOCK/ALARM TIME FAST SET BUTTON	12. DIAL POINTER
3. ALARM OFF BUTTON	13. LED DISPLAY
4. AM/FM BAND SELECTOR	14. TUNING KNOB
5. ALARM 1/2 SELECTOR	15. SPEAKER
6. FUNCTION SELECTOR (ON/OFF/AUTO/ALARM)	16. AUX IN Jack
7. VOLUME CONTROL/ BEEP ALARM SWITCH	17. USB CHARGING PORT
8. ALARM SET BUTTON	18. FM WIRE ANTENNA
9. TIME SET BUTTON	19. AC POWER CORD
10. SLEEP BUTTON	

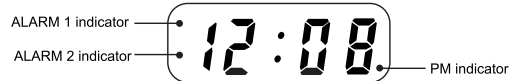

1. ALARM 1 INDICATOR	3. PM INDICATOR
2. ALARM 2 INDICATOR	

SETTING THE CLOCK

When you plug the radio into an AC outlet for the first time, the clock display will begin flashing "12:00". The flashing will stop when you set the time.

1. Press and hold the TIME SET button and then press the FAST button to quickly step through the digits when setting the Hour/Minutes.
2. Press and hold the TIME SET button and then press the SLOW button to set the correct Hour/Minutes.

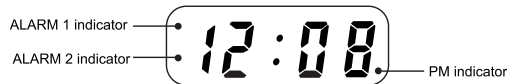

NOTE

There is a PM INDICATOR located in the bottom right-hand corner of the clock display. Be sure to observe the PM indicator when setting the time to make sure the time is set correctly for AM or PM. If the PM indicator is 'On', the time displayed is "PM". If the PM indicator is 'Off', the time displayed is "AM".

LISTENING TO THE RADIO

1. Set the AM/FM BAND SELECTOR to the desired band, AM or FM.
2. Slide the FUNCTION SELECTOR to the "ON" position.
3. Select your desired station with the TUNING knob.
4. Adjust the VOLUME knob to the desired listening level.
5. When you have finished listening, slide the FUNCTION SELECTOR to the "OFF" position to turn the radio off.

TIPS FOR BEST RADIO RECEPTION

AM - The AM antenna is built inside the radio. If AM reception is weak, slightly rotate the unit or change the position of the unit until the internal antenna picks up the strongest signal.

FM - If FM reception is weak, fully extend the wire antenna and vary the position and location of the antenna until you find the strongest signal.

CHARGING YOUR SMART PHONE OR PORTABLE DEVICE

This unit features a USB port for charging your portable device (iPod, iPhone, Android phone, etc.) when used with the USB charging cord that came with your device.

1. Plug one end of the USB cable (not included) into the USB port located on the back of the JCR-260. Plug the other end of the cord into the device you wish to charge.
2. Observe the battery charge indicator on your device and the charging will start immediately.
3. Unplug the cable when your device is charged.

CAUTION:

Before charging, please refer to the user manual of the device you wish to charge to make sure the charging current required does not exceed 1Amp (1,000 mA) of charging current. Overloading the charge circuit may damage the JCR-260 and void the warranty.

NOTE:

1. Some smart phones and portable devices use proprietary USB connections and circuitry, so they may not charge when plugged into the USB port. This includes older Apple iPod models including the iPod classic. Please refer to your device user manual before you attempt to charge them.
2. It is normal for the JCR-260 to be warm while the USB port is in use and charging your smart phone or portable device.
3. Do not charge your smart phone over 12 hours continuously. Remove your smart phone from the charger once it is charged.

AUX IN OPERATION

This unit features an AUX IN jack for connecting your iPod, MP3 player or other digital music player.

1. Connect the headphone jack of your external device to the AUX IN jack located on the back of the JCR-260 (cable not included).
2. Turn the JCR-260 on and it will enter the AUX IN mode once an external device is plugged into the AUX IN jack.
3. Start playing your iPod, MP3 player or other external audio device.
4. Slowly adjust both volume controls on the JCR-260 and the external device.
5. Turn off your iPod, MP3 player etc. when finish listening. Turn the JCR-260 off and unplug the AUX IN jack.

Remark: The JCR-260 will automatically enter the AUX IN mode no matter what position the AM/FM Band Selector switch is in when a cord is plugged into the AUX IN jack and the power is ON.

NOTE: It's important to remember to disconnect the cable from JCR-260 after use in order to be able to listen to the radio again.

ALARM OPERATION**SETTING THE WAKE UP TIME**

1. Press and hold the ALARM SET button and then press the FAST button to quickly step through the digits when setting the Hour/Minutes.
2. Press and hold the ALARM SET button and repeatedly press the SLOW button to set the correct wake up Hour/Minutes.

NOTE

1. There is a PM INDICATOR located in the bottom right-hand corner of the clock display. Be sure to observe the PM indicator when setting the alarm to make sure the alarm time is set correctly for AM or PM. If the PM indicator is 'On', the alarm time will be "PM". If not, the alarm time will be "AM".

2. If you plan to set dual alarms, the second alarm will not sound if first alarm is still sounding. Therefore, please make sure there is a sufficient time interval between the two alarms.

CHECKING THE WAKE UP TIME

Whenever you want to check the wake up time, set the FUNCTION SELECTOR to "AUTO" position, set the ALARM SELECTOR to ALARM 1 or ALARM 2 and press the ALARM SET button. The display will change from current time to wake up time for the ALARM time you selected. Release the ALARM SET button to return to current time.

WAKE TO RADIO

1. Slide the FUNCTION SELECTOR to "ON" position, select the band, station, and adjust the volume to a level that you wish to hear when the wake up time is reached, then slide the FUNCTION SELECTOR to the "AUTO" position. The selected alarm indicator will light on the display.
2. Reconfirm the wake up time setting by pressing the ALARM SET button.
3. At the selected wake up time the radio will turn 'On' and will play for about one hour and then shut off automatically if you don't press the SNOOZE button or turn the ALARM OFF manually.
4. To stop the radio before it shuts off, press the ALARM OFF button. The radio will stop but the alarm remains set and will turn the radio on again at the same time on the following day.
5. If you do not want the radio to turn on the following day, set the FUNCTION SELECTOR to the "OFF" position. The alarm indicator will go off.

WAKE TO ALARM

1. Rotate the VOLUME control knob until you hear a "Click" sound to turn on the BEEP ALARM. Set the ALARM SELECTOR to ALARM 1, ALARM 2 or ALARM 1+2 position. The related alarm indicator will light up to confirm that the corresponding alarm is set.
2. Slide the FUNCTION SELECTOR to the "AUTO" position
3. At the selected wake up time the alarm will beep and continue for about one hour and then shut off automatically if you don't press the SNOOZE button or turn the ALARM OFF manually.
4. If you want to listen to the radio after the wake up time, adjust the VOLUME knob to switch off beep alarm & turn up the volume level. Adjust the TUNING knob for the radio program if required.
5. To stop the beep alarm immediately, press the ALARM OFF button once. The beep will stop but the alarm remains set and will turn on the alarm on again at the same time the following day.
6. If you do not want the alarm to turn on the following day, set the FUNCTION SELECTOR to the "OFF" position. The alarm indicator will go off.

SNOOZE ALARM

After the radio or beeping sounds, you may press the SNOOZE button for a few more minutes sleep. The alarm will stop for approximately 7 minutes and then turn on again.

SLEEP OPERATION

SLEEP TO MUSIC

You can program the sleep timer to play the radio for up to 59 minutes and then shut off automatically.

1. Slide the FUNCTION SELECTOR to "ON", select the band, station, and volume level that you want to listen then slide the FUNCTION SELECTOR to either the "OFF" or "AUTO" position.
2. Press the SLEEP button, the display will show 0:59 sleep time. At the same time radio will come on and stay on for 59 minutes.
3. To shorten the 'SLEEP' time to less than "0:59", press and hold the SLEEP button and then press the SLOW button until the desired "SLEEP" time, between "0:59" and "0:01", is shown on display.
4. To set at the maximum sleep time of 0:59, press the Sleep button. The display will show "0:59" sleep time and the radio will begin to play. After 59 minutes, the radio will shut off automatically.
5. After the preset "SLEEP" time has elapsed, the radio will switch off automatically. To switch the radio off before the preset "SLEEP" time has elapsed, press the SNOOZE button.

SLEEP AND WAKE TO MUSIC

1. Slide the FUNCTION SELECTOR to "ON" position and select the band, station, and volume level that you wish to hear when the alarm comes 'On', then slide the FUNCTION SELECTOR to the "AUTO" position. The alarm INDICATOR will light up.
2. Follow steps 2 to 4 in "SLEEP TO MUSIC" section above to set your desired sleep time.
3. The unit is now programmed to turn off automatically at the Sleep Time you selected and then to turn on at the preset "Alarm Time".
4. To cancel the sleep timer before it counts down to "00" and shut the radio off, press the SNOOZE button.

IMPORTANT:

Remember that the station and volume settings you choose for the SLEEP TO MUSIC operation are the same settings you will hear if you set the alarm for wake to "MUSIC" the following morning.

CARE AND MAINTENANCE

1. If the cabinet becomes dusty, wipe the exterior with a soft dust cloth only. Never use dusting sprays or polishes on the cabinet.
2. If the cabinet becomes dirty or smudged with fingerprints it may be wiped with a soft cloth that has been slightly dampened with a mild soap and water solution. Never use abrasive cleansers or chemical solvents.
3. Always disconnect the power cord from the AC outlet before cleaning. Never allow any liquid to get inside the cabinet.
4. Should any solid object or liquid fall into the unit, unplug the unit and have it checked by qualified personnel before operating it any further.

NOTE

If there is no battery in the back-up battery compartment, the Time and Alarm settings will be lost when the AC power cord is disconnected for cleaning. Reset the clock and wake up time after reconnecting the AC power cord.

SPECIFICATION

Frequency Range:	AM 530 – 1710 kHz FM 88 – 108 MHz
AC Power Source:	120V~ 60Hz 10W
Backup Battery:	1 x 9V:: 006P type 6F22 battery (not included)



At Spectra, environmental and social responsibility is a core value of our business. We are dedicated to continuous implementation of responsible initiatives with an aim to conserve and maintain the environment through responsible recycling.

Please visit us at <http://www.spectrainl.com/green.htm> for more information on Spectra's green initiatives or to find a recycler in your area.

**90 DAY LIMITED WARRANTY AND SERVICE
VALID IN THE U.S.A ONLY**

SPECTRA MERCHANDISING INTERNATIONAL, INC. warrants this unit to be free from defective materials or factory workmanship for a period of 90 days from the date of original customer purchase and provided the product is utilized within the U.S.A. This warranty is not assignable or transferable. Our obligation under this warranty is the repair or replacement of the defective unit or any part thereof, except batteries, when it is returned to the SPECTRA Service Department, accompanied by proof of the date of original consumer purchase, such as a duplicate copy of a sales receipt.

You must pay all shipping charges required to ship the product to SPECTRA for warranty service. If the product is repaired or replaced under warranty, the return charges will be at SPECTRA's expense. There are no other express warranties other than those stated herein.

This warranty is valid only in accordance with the conditions set forth below:

1. The warranty applies to the SPECTRA product only while:
 - a. It remains in the possession of the original purchaser and proof of purchase is demonstrated.
 - b. It has not been subjected to accident, misuse, abuse, improper service, usage outside the descriptions and warnings covered within the user manual or non-SPECTRA approved modifications.
 - c. Claims are made within the warranty period.
2. This warranty does not cover damage or equipment failure caused by electrical wiring not in compliance with electrical codes or SPECTRA user manual specifications, or failure to provide reasonable care and necessary maintenance as outlined in the user manual.
3. Warranty of all SPECTRA products applies to residential use only and is void when products are used in a nonresidential environment or installed outside the United States.

This warranty gives you specific legal rights, and you may also have other rights which vary from state to state. TO OBTAIN SERVICE please remove all batteries (if any) and pack the unit carefully and send it freight prepaid to SPECTRA at the address shown below. IF THE UNIT IS RETURNED WITHIN THE WARRANTY PERIOD shown above, please include a proof of purchase (dated cash register receipt) so that we may establish your eligibility for warranty service and repair of the unit without cost. Also include a note with a description explaining how the unit is defective. A customer service representative may need to contact you regarding the status of your repair, so please include your name, address, phone number and email address to expedite the process.

IF THE UNIT IS OUTSIDE THE WARRANTY PERIOD, please include a check for \$12.00 to cover the cost of repair, handling and return postage. All out of warranty returns must be sent prepaid.

It is recommended that you contact SPECTRA first at 1-800-777-5331 or by email at custserv@spectrainintl.com for updated information on the unit requiring service. In some cases the model you have may be discontinued, and SPECTRA reserves the right to offer alternative options for repair or replacement.

SPECTRA MERCHANDISING INTERNATIONAL, INC.
4230 North Normandy Avenue,
Chicago, IL60634, USA.
1-800-777-5331

To register your product, visit the link on the website below to enter your information.
<http://www.spectrainintl.com/wform.htm>

0212

Printed in China